

The Seventh Annual Robotic Lawnmower Competition Rulebook

Revision 2010.1.0

June 3-5, 2010

Dayton, Ohio

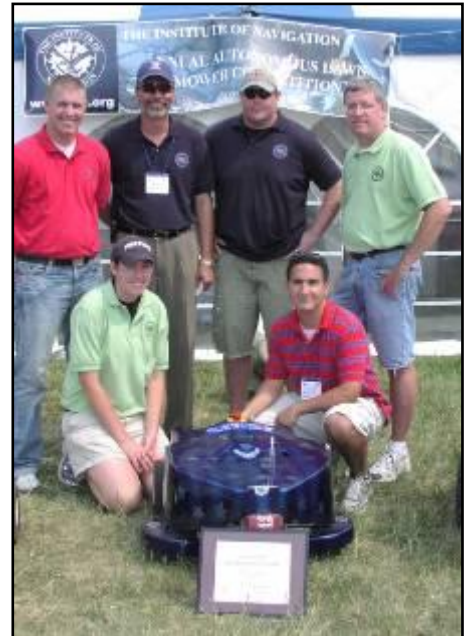

Sponsored by:



The Institute of Navigation-
Satellite Division



Air Force Research Laboratory-
Sensors Directorate

1 GENERAL OVERVIEW3

1.1 GENERAL TEAM RULES.....3

1.2 BEST CUT AWARD4

1.3 IMPORTANT DATES5

1.4 DOCUMENT REVISION HISTORY:.....5

2 CATEGORY I: BASIC MOWING FIELD AUTONOMOUS LAWNMOWER CONTEST6

2.1 OVERVIEW6

2.2 RULES & REGULATIONS.....6

 2.2.1 *Mower Design*.....6

 2.2.2 *Safety Check*.....6

 2.2.3 *Qualification*.....7

 2.2.4 *Mowing*.....7

2.3 FIELD DESCRIPTION7

2.4 SCORING8

 2.4.1 *Report Scoring*.....9

 2.4.2 *Technical Presentation Scoring*.....9

 2.4.3 *Mowing Competition Scoring*.....10

 2.4.4 *Total Scoring*.....10

2.5 PRIZES.....11

3 CATEGORY II: ADVANCED AUTONOMOUS MOWING FIELD CONTEST.....12

3.1 OVERVIEW12

3.2 RULES & REGULATIONS.....12

 3.2.1 *Mower Design*.....12

 3.2.2 *Safety Check*.....12

 3.2.3 *Qualification*.....13

 3.2.4 *Mowing*.....13

3.3 FIELD DESCRIPTION13

3.4 MOVING OBSTACLE DESCRIPTION15

3.5 FLOWER BED DESCRIPTION15

3.6 SCORING15

 3.6.1 *Report Scoring*.....16

 3.6.2 *Technical Presentation Scoring*.....16

 3.6.3 *Mowing Competition Scoring*.....17

 3.6.4 *Total Scoring*.....18

3.7 PRIZES.....18

APPENDIX A, STATIC OBSTACLE DESCRIPTION.....19

APPENDIX B, DYNAMIC OBSTACLE DESCRIPTION20

APPENDIX C, PICKET FENCE DETAILS.....21

1 General Overview

The Institute of Navigation (ION) announces the Seventh Annual Robotic Lawnmower Competition sponsored by the ION's Satellite Division, Air Force Research Laboratory.

The purpose of this competition is to design and operate an autonomous unmanned lawnmower using the art and science of navigation to rapidly and accurately mow a field of grass.

This year the competition will consist of the following two categories: Basic Autonomous Mowing and Advanced Autonomous Mowing. The Basic Mowing Competition field will be rectangular with one static (non-moving) obstacle. The Advanced Mowing Competition field will have a non square shape and contain both static and moving obstacles as well as a border such as a fence. Teams are permitted to compete in either the basic or the advanced course- schools are permitted to have more than one team. Given favorable field conditions, a separate award will be awarded to the team which cuts the field with the "best cut." Details on the best cut award can be found in section 1.2.

Changes for 2010!

- *Section 3.3: All sides of Zone 1 are not guaranteed to be square.*

The competition will take place 3-5 June, 2010 - a Thursday, Friday, and Saturday (with Sunday the 6th of June as a rain date), and will be held at Siebenthaler's Beaver Valley Garden Center near Dayton, OH. Presentations shall be given Thursday afternoon at **TBD** in Dayton, OH; the inspection and qualification shall be Friday; and the mowing competition shall take place on Saturday.

Teams competing in the Basic and Advanced categories will be scored separately. The winning teams for both categories are based on the highest total score. Scoring details for each category in the mowing competition are provided in their respective sections. There will be cash awards presented to the top three teams in each category. In addition, special international recognition will be provided for all participating teams through ION publications and announcements at the 2010 ION Global Navigation Satellite Systems (GNSS) conference. The winning teams will also be given an invitation to display their lawnmowers during the ION GNSS, and given the opportunity to make a 20-minute presentation on their robotic lawnmower design. Finally, videotapes of the competition event will be distributed to sponsors, media, and the public.

1.1 General Team Rules

1. Teams may be comprised of undergraduate and/or graduate students, and must be supervised by at least one faculty advisor. Interdisciplinary teams are encouraged (EE, ME, CS, etc.). Only the student component of each team will be eligible for the awards. The faculty supervisor will certify that all team members are students on the application form. Business/Non-Engineering students are encouraged to join teams to promote marketing, sponsorships, and other program management functions.

2. Team sponsors are encouraged. Sponsors' participation will be limited to hardware donation and/or funding support. Sponsors' logos may be placed on the lawnmower and may be displayed inside the team's maintenance area. Teams should encourage sponsor attendance.
3. A non-secured sheltered maintenance area will be provided.
4. Schools may have more than one entry. Each entry must be based on a different mower (chassis & electronics), different team, and must be documented by a separate application forms and team reports. Each form must be accompanied with a \$200.00 non-refundable registration fee made payable to: ION, Dayton Section. This fee includes up to five ION student memberships.
5. The Application Form must contain an **Indemnification Agreement** executed by an individual from the team's sponsoring institution who has authority to bind the institution for which he or she signs. Additionally, the Team's sponsoring institution is required to supply the Dayton Section of the Institute of Navigation with a Certificate of Insurance at the time the Application Form is submitted. The certificate must show commercial general liability coverage in an amount not less than \$1 million.
6. Intention to compete must be received no later than **April 16, 2010**, by mailing your application form to Lisa Beaty, Institute of Navigation, 8551 Rixlew Lane, Suite 360, Manassas, VA 20109.

1.2 Best Cut Award

The Best Cut Award will be presented to the team who cuts as least 75% of their field and has the most aesthetically pleasing cut. Since the definition of "aesthetically pleasing" is subjective, professionals from the lawn-care business will be on hand to do the judging. A cash award will be given to the team whose field is deemed "best cut." The value of the award is dependent on the sponsorship of the competition and favorable field conditions the day of the competition- please refer to the official Robotic Lawnmower Webpage (www.automow.com) for the latest award amount information.

1.3 Important Dates

- April 16, 2010 - Application forms due
- May 13, 2010 - Reports are due by 5:00 PM
- June 3, 2010 - Presentations in the evening
- June 4, 2010 - Robotic lawnmower qualification
- June 5, 2010 - Mowing competition
- June 6, 2010 - Rain date for competition

1.4 Document Revision History:

- Revision 2010.1.0
 - Baseline Document

2 Category I: Basic Mowing Field Autonomous Lawnmower Contest

2.1 Overview

Design and operate an autonomous unmanned lawnmower using the art and science of navigation to rapidly and accurately mow a rectangle field of grass with static (non-moving) obstacles. The teams are placed based on their total scores; 80% of the total score is based on the mowing competition; 20% of the total score is based on the presentation and report.

2.2 Rules & Regulations

2.2.1 Mower Design

1. Lawnmowers shall be autonomous and unmanned and shall not be remotely controlled during the competition. Remotely controlled includes but is not limited to: commands to reset the mowers computers, commands to reinitialize the mower, commands to adjust a mowing route, etc.
2. For safety, a maximum lawnmower speed of 10 km/hr shall be enforced.
3. The lawnmower shall be equipped with both a manual and a wireless (radio frequency) remote emergency stop capability. The wireless emergency stop shall be effective for the entire field of operation plus 10 m in all directions. The manual emergency stop shall be easily accessible by a standing operator behind the lawnmower, and shall be **red** in color and have a diameter of at least **40 mm**. After the initiation of an emergency stop, the mowing function shall cease within 3 s and the lawnmower shall be stopped within a distance of 2 m. Lawnmowers that are determined to be unsafe by the judges shall not be operated in the competition.
4. Mower may not exceed 2 m in any dimension
5. Lawnmower movement shall be accomplished through direct contact with the ground. Power shall either be provided by combustible fuel, batteries, or both. Other power sources should be cleared with the judging officials prior to the competition.

2.2.2 Safety Check

The safety check is conducted to test the functionality of the lawnmower manual and wireless emergency stop, and verify that the top speed of the lawnmower is below 10 km/h. Lawnmowers that fail to meet these requirements before the designated competition start time will be disqualified by the Safety Officials. Teams may fine tune their lawnmowers and resubmit for inspection and/or safety test. After passing the safety qualification test, changes to maximum speed control software and hardware are not allowed.

2.2.3 Qualification

All entries are required to qualify to compete the mowing competition. The lawnmowers must demonstrate the ability to mow a **predetermined** path void of any obstacles. The shape and complexity of the predetermined path should be chosen by the teams and approved by the Qualifying Official. At a minimum the predetermined path shall include 3 turns at predetermined locations, and the path shall not exceed an area with 10 m by 10 m dimensions. In the event of any conflict, the judges' decision is final.

2.2.4 Mowing

1. The competitors will be required to start autonomous operation in the safety buffer and mow in the cutting zone. Teams may choose any location in the safety zone to start their run.
2. If any part of the lawnmower is outside the safety buffer (2 m in any direction outside the field of operation), the emergency stop shall be activated, and the run terminated.
3. The lawnmower shall start operation within 5 minutes after the assigned start time. The timer will be started from zero when the lawnmower crosses the start line. The team shall declare completion of the mowing operation.
4. Teams are permitted restarts. If a team chooses to restart a penalty will be assessed as detailed in the scoring section. If a restart is requested, teams will be given 1 hour to prepare for next attempt, and as with the initial run, teams may choose any location in the safety zone to restart their run.
5. Teams have a maximum of 20 minutes to cut the field. The 20 minutes is total cutting time, i.e. it includes the initial run and possible restart.
6. The mowers should be designed to operate in any weather condition. In the event of inclement weather the competition may be postponed. Teams may not work on their mowers while the event is postponed. The decision to postpone shall be made by the judges.

2.3 Field Description

The cutting field will be approximately 10 m by 15 m in size surrounded by a 2 m safety buffer as illustrated in Figure 2-1. The boarder of the fields will be marked with painted lines. The line separating the cutting field from the safety field will be white, and the outside of the safety buffer will either be yellow or white. The field will contain two obstacles; the location of these obstacles will be given to the teams during the qualification rounds. Diagrams the obstacles can be found in Appendix A.

The quality of the cutting fields may vary, and each team's field will be chosen at random during the qualification rounds. When designing their mower, teams should anticipate a rough mowing field which may be wet. Field inclines will not exceed 1 in 10 m and the GPS mask angle shall not exceed 35 degrees in any direction. Utility poles, utility wires, and goal posts may exceed the 35 degree GPS mask angle.

Teams will be randomly assigned a practice and competition field the morning of the qualification round- at that time they may practice and program their autonomous lawnmowers on an assigned practice field and survey their assigned competition field. Teams will not be permitted to enter their assigned competition field prior to their assigned competition start time to preserve the quality of the grass.

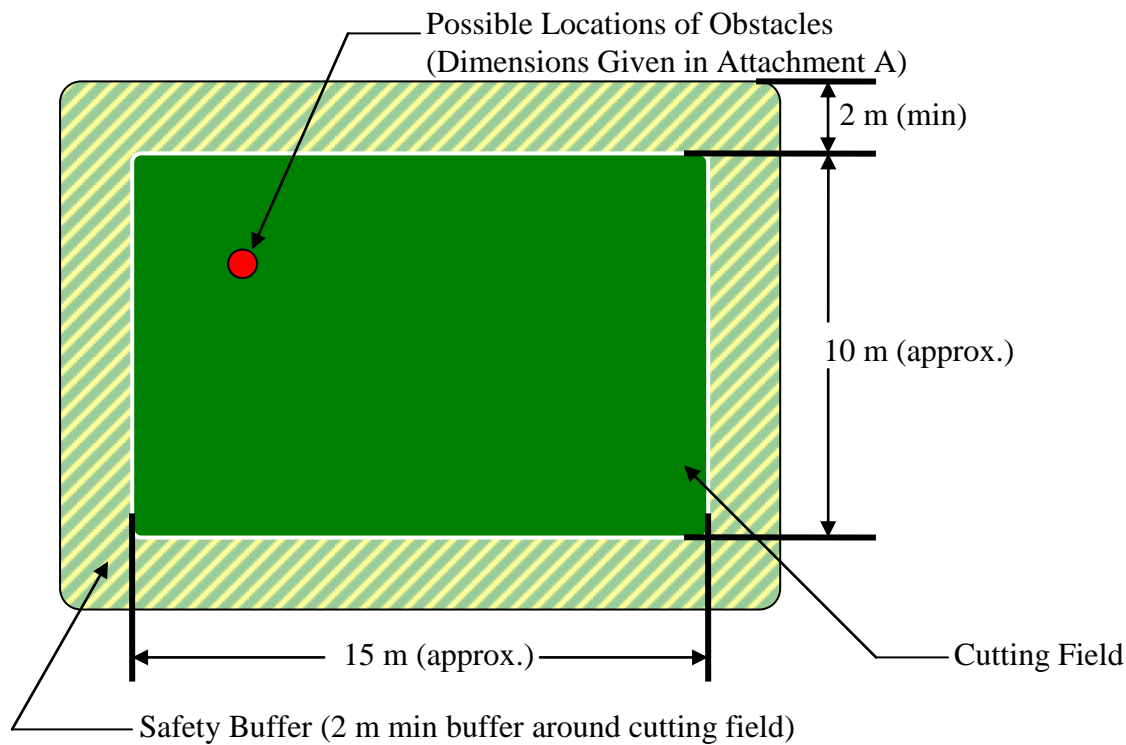

Figure 2-1, Lawn Mowing Field for the Basic Category. NOTE: Field size at the time of competition may vary.

2.4 Scoring

Competitors are placed based on their total score in the competition. The total score is a composite of the points earned on the team's report, the team's presentation, and the mowing competition. The individual components and the total scoring algorithms are given in this section.

2.4.1 Report Scoring

Each team shall submit a report no later than 5:00 PM on Thursday, May 13, 2010. The report shall be submitted electronically to donald.venable@wpafb.af.mil. If the size of the report exceeds size permitted by recipient's mailbox (5 MB) other arrangements should be made *before* the deadline. Late reports will be assessed a penalty of 10 points per work day from the total point score of 100.

The report shall contain a summary of the lawnmower and associated navigation design. Teams are encouraged to submit their report at the earliest opportune time. Some small changes to the final lawnmower design after the report has been submitted shall be tolerated.

The report scoring is out of 100 points and shall be as follows:

1. Overview of team organization and lawnmower design	10
2. Quality of documentation (Grammar and Style)	10
3. Effective innovation of overall lawnmower design	25
4. Completeness of overall system specifications- for example:	10
a. Cost	
b. Max speed	
c. Cutting width	
d. Dimensions	
e. Gasoline (or other energy source) usage (i.e. gallons per sqr yard cut or gallons per hr)	
f. others	
5. Description of electronic design	10
6. Description of software strategy	10
7. Description of systems integration	15
8. Attention given to safety, reliability, and durability	10
TOTAL	100

2.4.2 Technical Presentation Scoring

Each team shall give a technical presentation on Thursday, 3 June 2010. The presentation should be 15 minutes in length. A projector and computer with Microsoft PowerPoint shall be provided. Teams are not required to use the provided computer but if they do, it is recommended they email the presentation to donald.venable@wpafb.af.mil for loading, and bring a backup copy on either a CD or on a memory stick.

The technical presentation scoring is out of 100 points and shall be as follows:

1. Clarity of presentation (intro, body, summary)	40
2. Level of relevance to the technical report	40
3. Ability to capture the audience's interest	20
TOTAL	100

2.4.3 Mowing Competition Scoring

The mowing competition scoring has been greatly simplified this year. No longer will the scoring be weighted by the time required to cut or the mowing blades width. The score will be based only on the percentage of grass mowed in the cutting area with penalties assigned for grass cut in the safety buffer and for impact with obstacles. A 15% penalty will be assessed for each restart. Only two restarts are allowed. Teams have ten minutes after the end of each run to declare a restart. If a restart is not declared within the end of the teams run, the team's final score will be calculated and posted.

Percentage of the grass mowed will be determined by the following equation:

$$P_{GM} = \left(\frac{A_{CA} - A_{SB}}{A_{TA}} - 0.10N_I \right) \times 100\% - N_{RS} \times 15\% \quad (1)$$

where:

- P_{GM} = Percentage of the grass mowed (score)
- A_{CA} = Area of grass cut in the cutting area
- A_{SB} = Area of grass cut in the safety buffer
- A_{TA} = Total area of the cutting area
- N_I = Number of Impacts which move an obstacle
- N_{RS} = Number of Restarts

Cutting grass on the line which separates the cutting area with the safety buffer is considered cutting in the safety buffer and is a penalty. Touching a stationary obstacle is not considered a penalty if the stationary obstacle does not move. If a stationary obstacle is impacted with a force which causes the obstacle to visibly slide, a 10 percent penalty is assessed per impact as described in (1). Judges have the final decision on penalties assessed- there are no 'video replay' challenges permitted.

2.4.4 Total Scoring

All rulings and scoring by the judges shall be final.

Total score is a composite of the mowing competition (80%), technical report (10%), and technical presentation (10%).

In the event of a tie, the team which cut the grass in the least amount of time will be declared the winner.

2.5 Prizes

The prize amounts are based on the number of sponsors and values will be posted on the web page (www.automow.com). **To qualify for total dollar prize amounts the team must mow at least 50% of the cutting field during their competition run.** If less than 50% of the field is mowed the team will only receive 25% of the total prize.

3 Category II: Advanced Autonomous Mowing Field Contest

3.1 Overview

Design and operate an autonomous unmanned lawnmower using the art and science of navigation to rapidly and accurately mow an “L” shaped field of grass with moving and static obstacles. The teams are placed based on their total scores; 80% of the total score is based on the mowing competition; 20% of the total score is based on the presentation and report.

3.2 Rules & Regulations

3.2.1 Mower Design

1. Lawnmowers shall be autonomous and unmanned and shall not be remotely controlled during the competition. Remotely controlled includes but is not limited to: commands to reset the mowers computers, commands to reinitialize the mower, commands to adjust a mowing route, etc.
2. For safety, a maximum lawnmower speed of 10 km/hr shall be enforced.
3. The lawnmower shall be equipped with both a manual and a wireless (radio frequency) remote emergency stop capability. The wireless emergency stop shall be effective for the entire field of operation plus 10 m in all directions. The manual emergency stop shall be easily accessible by a standing operator behind the lawnmower, and shall be **red** in color and have a diameter of at least **40 mm**. After the initiation of an emergency stop, the mowing function shall cease within 3 s and the lawnmower shall be stopped within a distance of 2 m. Lawnmowers that are determined to be unsafe by the judges shall not be operated in the competition.
4. Mower may not exceed 2 m in any dimension
5. Lawnmower movement shall be accomplished through direct contact with the ground. Power shall either be provided by combustible fuel, batteries, or both. Other power sources should be cleared with the judging officials prior to the competition.

3.2.2 Safety Check

The safety check is conducted to test the functionality of the lawnmower manual and wireless emergency stop, and verify that the top speed of the lawnmower is below 10 km/h. Lawnmowers that fail to meet these requirements before the designated competition start time will be disqualified by the Safety Officials. Teams may fine tune their lawnmowers and resubmit for inspection and/or safety test. After passing the safety qualification test, changes to maximum speed control software and hardware are not allowed.

3.2.3 Qualification

All entries are required to qualify to compete the mowing competition. The lawnmowers must demonstrate the ability to mow a **predetermined** path void of any obstacles. The shape and complexity of the predetermined path should be chosen by the teams and approved by the Qualifying Official. At a minimum the predetermined path shall include 3 turns at predetermined locations, and the path shall not exceed an area with 10 m by 10 m dimensions. In the event of any conflict, the judges' decision is final.

3.2.4 Mowing

1. The competitors will be required to start autonomous operation in the safety buffer and mow in the cutting zone. Teams may choose any location in the safety zone to start their run *as long as the first grass cut on the cutting field is in Zone 1*.
2. If any part of the lawnmower is outside the safety buffer (2 m in any direction outside the field of operation), the emergency stop shall be activated, and the run terminated.
3. The lawnmower shall start operation within 5 minutes after the assigned start time. The timer will be started from zero when the lawnmower crosses the start line. The team shall declare completion of the mowing operation.
4. Teams are permitted restarts. If a team chooses to restart a penalty will be assessed as detailed in the scoring section. If a restart is requested, teams will be given 1 hour to prepare for next attempt, and as with the initial run, teams may choose any location in the safety zone to restart their run *as long as the mower enters the field in Zone 1*.
5. Teams have a maximum of 20 minutes to cut the field. The 20 minutes is total cutting time, i.e. it includes the initial run and possible restarts.
6. The mowers should be designed to operate in any weather condition. In the event of inclement weather the competition may be postponed. Teams may not work on their mowers while the event is postponed. The decision to postpone shall be made by the judges.

3.3 Field Description

The cutting field will be a three zoned irregular shape surrounded by a 2 m safety buffer as illustrated in Figure 3-1. The boarder of the fields will be marked with painted lines. The line separating the cutting field from the safety field will be white, and the outside of the safety buffer will either be yellow or white. The field will contain one moving obstacle; details on the moving obstacle can be found in the next section. Diagrams of the moving obstacles can be found in Appendix B.

The quality of the cutting fields may vary, and each team’s field will be chosen at random during the qualification rounds. When designing their mower, teams should anticipate a rough mowing field which may be wet. Field inclines will not exceed 1 in 10 m and the GPS mask angle shall not exceed 45 degrees in any direction. Utility poles, utility wires, and goal posts may exceed the 45 degree GPS mask angle.

Teams will be randomly assigned a practice and competition field the morning of the qualification round- at that time they may practice and program their autonomous lawnmowers on an assigned practice field and survey their assigned competition field. Teams will not be permitted to enter their assigned competition field prior to their assigned competition start time to preserve the quality of the grass.

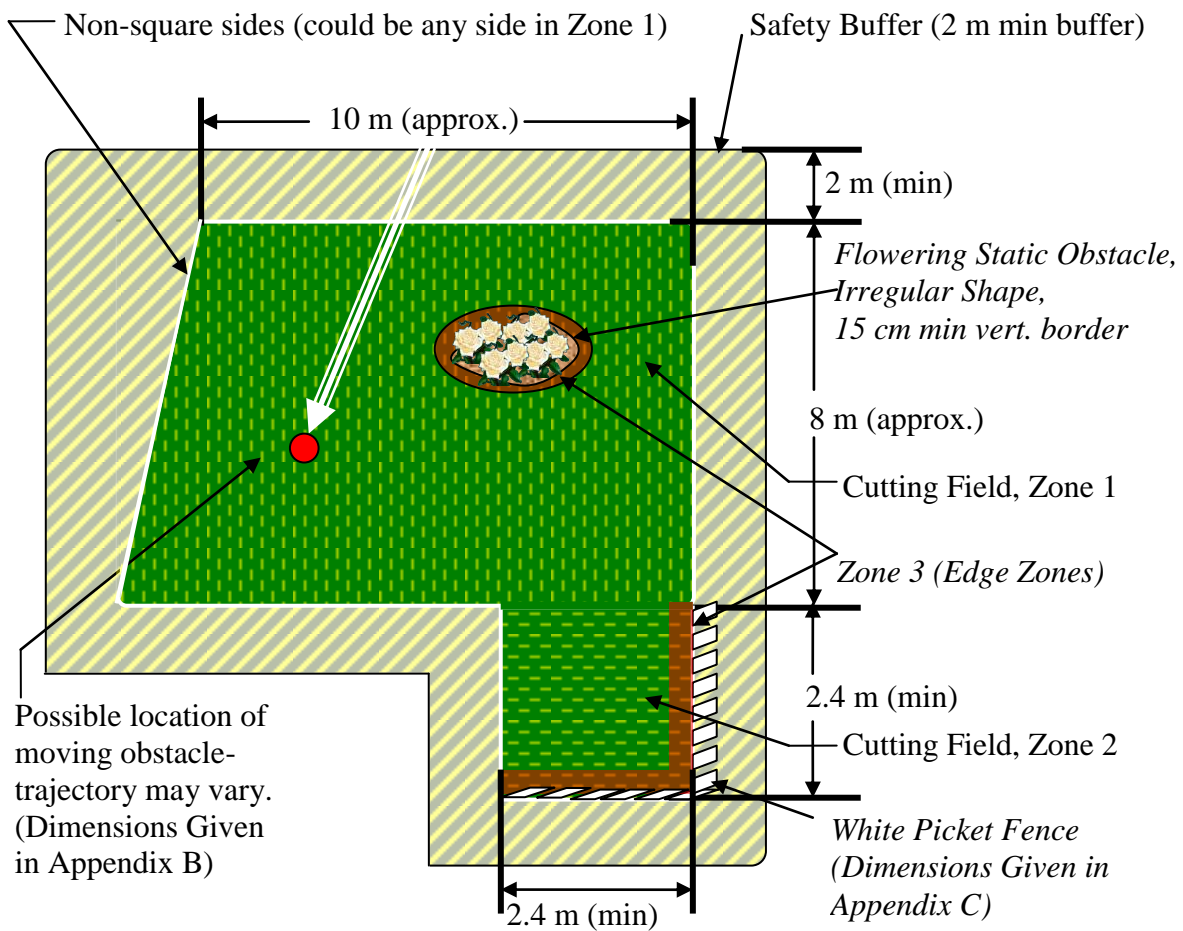

Figure 3-1, Autonomous Lawn Mowing Field for the Advanced Category. NOTE: field size, location and movement of obstacles may vary from picture.

3.4 Moving Obstacle Description

The moving obstacle will travel in a straight line towards the front (± 90 deg from mower's velocity vector) of a mower and will engage the mower once at a time chosen by the moving obstacle judge. The obstacle will move at a maximum speed of 3 m/s and its shape is described in Appendix B. The goal is to design a system which will prevent a team's mower from impacting the moving obstacle- thus, it can be assumed that the moving obstacle will not run into a team's mower (but a team's mower could run into the moving obstacle!)

3.5 Flower Bed Description

The flowerbed will be bordered with 15 cm high black plastic edging. The maximum dimension on the flower bed will not exceed 5 m, and the flowerbed will have a concave portion which has a minimum radius of 2 m. Non-concave portions of the flowerbed may contain corners. Figure 3-2 provides a notional flowerbed shape. Figure 3-3 provides a picture of the flowerbed from 2008; this year's flowerbed will be similar. There will be flowers in the flowerbed which may be taller than the plastic edging. The flowerbed will be positioned in Zone 1 of the cutting field. The position and orientation of the flower bed will not be set until 5 minutes before the start of run, and the teams may not input information to their robot which provides information on the position and orientation of the flowerbed. There will be a minimum of 2 m between all edges of the flowerbed and all edges of Zone 1 of the cutting field.

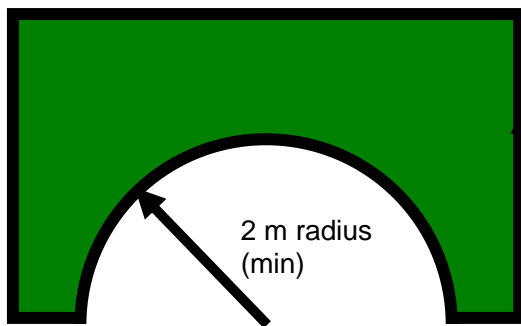

Figure 3-2, Notional flowerbed shape



Figure 3-3, 2008 Competition Flowerbed

3.6 Scoring

Competitors are placed based on their total score in the competition. The total score is a composite of the points earned on the team's report, the team's presentation, and the mowing competition. The individual components, total, and an example scoring are given in this section.

3.6.1 Report Scoring

Each team shall submit a report no later than 5:00 PM on Thursday, May 13, 2010. The report shall be submitted electronically to donald.venable@wpafb.af.mil. If the size of the report exceeds size permitted by recipient's mailbox (5 MB) other arrangements should be made *before* the deadline. Late reports will be assessed a penalty of 10 points per work day from the total point score of 100.

The report shall contain a summary of the lawnmower and associated navigation design. Teams are encouraged to submit their report at the earliest opportune time. Some small changes to the final lawnmower design after the report has been submitted shall be tolerated.

The report scoring is out of 100 points and shall be as follows:

9. Overview of team organization and lawnmower design	10
10. Quality of documentation (Grammar and Style)	10
11. Effective innovation of overall lawnmower design	25
12. Completeness of overall system specifications- for example:	10
a. Cost	
b. Max speed	
c. Cutting width	
d. Dimensions	
e. Gasoline (or other energy source) usage (i.e. gallons per sqr yard cut or gallons per hr)	
f. others	
13. Description of electronic design	10
14. Description of software strategy	10
15. Description of systems integration	15
16. Attention given to safety, reliability, and durability	10
TOTAL	100

3.6.2 Technical Presentation Scoring

Each team shall give a technical presentation on Thursday, June 3, 2010. The presentation will be 15 minutes in length.

A projector and computer with Microsoft PowerPoint shall be provided. Teams are not required to use the provided computer but if they do, it is recommended they email the presentation to donald.venable@wpafb.af.mil for loading, and bring a backup copy on either a CD or on a memory stick.

The technical presentation scoring is out of 100 points and shall be as follows:

4. Clarity of presentation (intro, body, summary)	40
5. Level of relevance to the technical report	40
6. Ability to capture the audience's interest	20

TOTAL

100

3.6.3 Mowing Competition Scoring

The mowing competition scoring has been greatly simplified this year. No longer will the scoring be weighted by the time required to cut or the mowing blades width. The score will be based only on the weighted percentage of grass mowed in the three specified cutting areas (Zone 1, Zone 2 and Zone 3 in Figure 3-1) with penalties assigned for grass cut in the safety buffer and for collision with the obstacles. A 15% penalty will be assessed for each restart. Only two restarts are allowed. Teams have ten minutes after the end of each run to declare a restart. If a restart is not declared within the end of the teams run, the team's final score will be calculated and posted.

Percentage of the grass mowed will be determined by the following equation:

$$P_{GM} = \left(0.3 \left(\frac{A_{CA_Z1}}{A_{TA_Z1}} \right) + 0.4 \left(\frac{A_{CA_Z2}}{A_{TA_Z2}} \right) + 0.3 \left(\frac{A_{CA_Z3}}{A_{TA_Z3}} \right) - \frac{A_{SB}}{A_{TA}} - 0.10N_I \right) \times 100\% - N_{RS} \times 15\% \quad (2)$$

where:

P_{GM} = Percentage of the grass mowed (score)

A_{CA_Z1} = Area of grass cut in the cutting area in Zone 1

A_{CA_Z2} = Area of grass cut in the cutting area in Zone 2

A_{CA_Z3} = Area of grass cut in the cutting area in Zone 3 (designated red edge zones)

A_{SB} = Area of grass cut in the safety buffer

A_{TA_Z1} = Total area of the cutting area in Zone 1

A_{TA_Z2} = Total area of the cutting area in Zone 2

A_{TA_Z3} = Total area of the cutting area in Zone 3 (designated red edge zones)

A_{TA} = Total area of the cutting area in Zone 1, 2 & 3 $\therefore A_{TA} = A_{TA_Z1} + A_{TA_Z2} + A_{TA_Z3}$

N_I = Number of time the team's lawnmower collides with moving or static obstacle

N_{RS} = Number of Restarts

As defined in (2), grass cut in Zone 1 (the largest zone) accounts for 30% of the mowing score, the grass cut in the smaller Zone 2 accounts for 40% of the mowing score, and the grass cut in Zone 3 accounts for 30% of the mowing score. Grass cut in the safety buffer penalizes the total score by percentage of area cut in the safety area scaled by the total cutting area. In addition, collisions with the moving obstacle will reduce the score by 10% for each collision.

Cutting grass on the line which separates the cutting area with the safety buffer is considered cutting in the safety buffer and is a penalty. The edge zones (Zone 3) will be 30 cm in width. Touching a stationary obstacle is not considered a penalty if the stationary obstacle does not

move and is not damaged. If a stationary obstacle is impacted with a force which causes the obstacle to visibly slide, a 10 percent penalty is assessed per impact as described in (2). Judges have the final decision on penalties assessed- there are no 'video replay' challenges permitted.

3.6.4 Total Scoring

All rulings and scoring by the judges shall be final.

Total score is a composite of the mowing competition (80%), technical report (10%), and technical presentation (10%).

In the event of a tie, the team which cut the grass in the least amount of time will be declared the winner.

3.7 Prizes

The prize amounts are based on the number of sponsors and values will be posted on the web page (www.automow.com). **To qualify for total dollar prize amounts the team must mow at least 50% of the cutting field during their competition run.** If less than 50% of the field is mowed the team will only receive 25% of the total prize.

Appendix A, Static Obstacle Description

No.	Description/Materials
1	BRUTE CONT. - PE

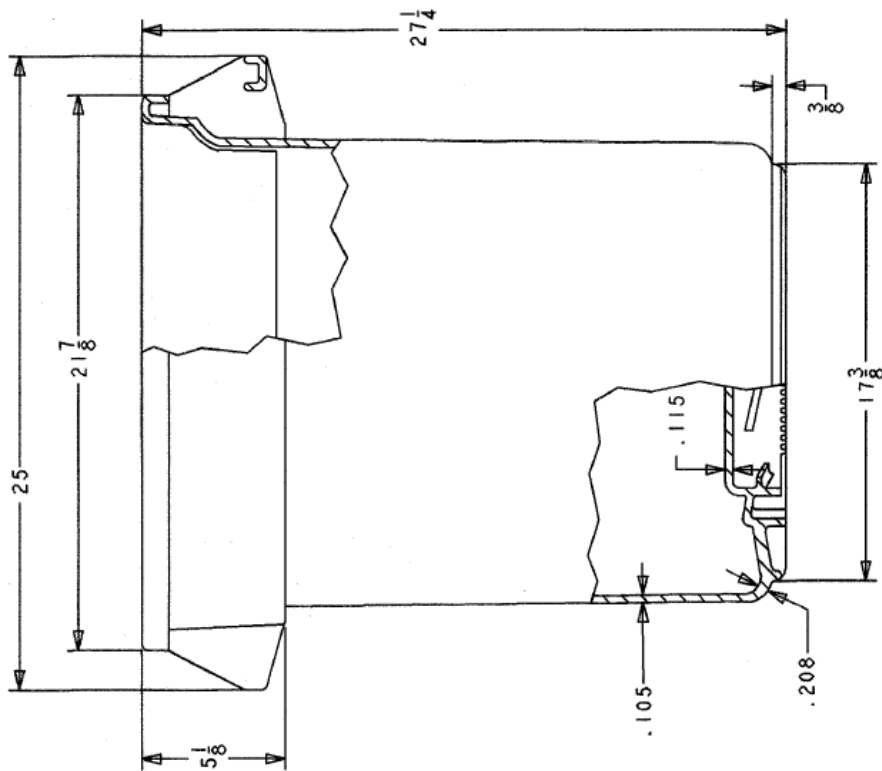
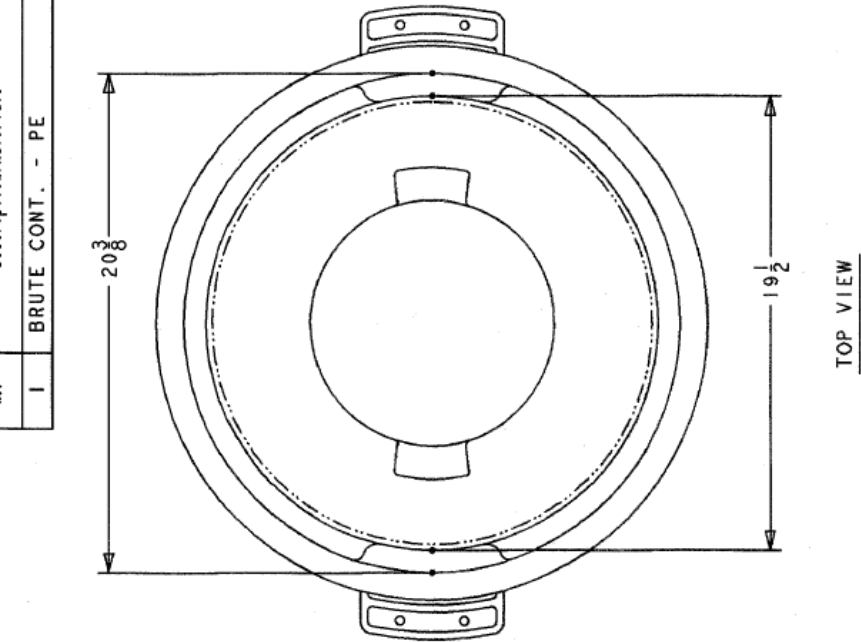

product no. 2632	
Product Specifications 	
total part wt. 8.0 LBS.	agency approvals NSF STD. #2 & #21, USDA MEAT & POULTRY, CSFM WHEN USED WITH 2637
capacity 32 GALS.	miscellaneous
product name BRUTE CONTAINER	product no. 2632 revision 6

Appendix B, Dynamic Obstacle Description

The moving obstacle will be a radio controlled truck with stuffed dog attached on top. The feet of the stuffed dog will be no more than 4 inches (~ 10 cm) above ground level.

The radio controlled dog will be driven in front (+/- 90 deg of the mowers' velocity vector) of the teams' mowers once during their run at a time determined by the "driver" of the dog.

The dog will stop in front of the mower for 30 seconds.

Moving Obstacle Specifications:

Melissa and Doug Lifelike and Lovable Plush Standard Poodle

Item #: 924013

SKU: C7E27438

UPC/EAN/ISBN: 000772048613

Manufacturer #: 4861

Dimensions: 27 x 21 x 6

<http://www.toysrus.com/product/index.jsp?productId=2668151>

Note : Amelia will not be riding the obstacle during the competition.



Appendix C, Picket Fence Details

Fence: 8' by 8' U shaped section off the main field

The fence will be a white plastic picket fence. Below is a link to the fence at Lowes.

Fence Specifications:

Freedom

36" x 8' White Classic Gothic Vinyl Picket Fence Panel

Item #: 56507 Model: 56507

<http://www.lowes.com/lowes/lkn?action=productDetail&productId=56507-73428-56507&lpage=none>

